



Quasar®

ROOM AIR CONDITIONER

INSTALLATION AND OPERATING INSTRUCTIONS

ENGLISH

MODEL: HQ-2102UH
HQ-2122UH



Please read these operating instructions thoroughly before using your air conditioner and keep them for future reference.

For assistance, please call: 1-800-211-PANA (7262) or send e-mail to consumerproducts@panasonic.com or refer to www.panasonic.com

© 2003 Matsushita Electrical Co., Ltd. All Right Reserved.

F564236



Please observe these following safety precautions when using your air conditioner.

- Failure or negligence in observing these safety precautions could cause fire, electrical shock or personal injury.



 This symbol (with a white background) denotes an action that is **PROHIBITED**.

 These symbols (with a blue background) denote actions that are **COMPULSORY**.

INSTALLATION PRECAUTIONS



-  • Due to the weight of this product, we recommend that you have a helper to assist in the installation. To avoid injury, use the proper method of lifting. Avoid any sharp edges.
- Make sure the window frame to be used can properly support this product.
- This product must be installed in accordance with all local codes and ordinances.
-  • Do not install the unit in places where inflammable gas, fumes or soot may be generated.

OPERATION PRECAUTIONS



-  • Operate your air conditioner from a stable 115 volt AC supply.
- Plug into a separate 15 amp grounded outlet only.
- Use of extension cords
Avoid using extension cords. If there are no alternatives, ensure that the cord is a UL listed 3-wire grounding type, rated 125 volts with a minimum current-carrying rating of 15 amps, number 14 or heavier wire.
-  • Use a 15 amp time delay fuse or a circuit breaker.
- Do not switch off by unplugging the power plug while it is operating. Press the OFF/ON pad to "OFF" before unplugging.

OPERATION PRECAUTIONS

 **WARNING** This sign warns of risk of death or serious injury.

-  • Do not modify the length of the power cord or use an extension cord.
- Do not touch or operate with wet hands. Do not modify or damage the cord.
- Do not turn on the unit by inserting the power plug. Do not switch off the unit by pulling out the power plug.
- Avoid an extended period of direct airflow.
- Do not insert sticks, fingers or other objects into the unit.
- Do not try to repair the unit yourself.
-  • Plug in properly before operating and use a specified power cord.
- If abnormal conditions (burnt smell, etc) occur, switch off and remove the power plug.

 **CAUTION** This sign warns of injury or damage to property.

-  • Do not use the unit for other purposes, than its intended use.
- Do not remove the power plug by pulling the cord.
- Do not block the air intake and outlet vanes.
- Do not splash or direct water at the unit
- Do not expose the unit to direct sunlight during operation.
- Do not operate the unit without the air filter installed or when the front intake grille has been removed.
- Do not place any objects on the unit.
- Do not operate any combustion equipment near the unit's airflow area.
-  • Switch off the breaker and remove the power plug from the socket if the unit will not be operated for a long period.
- Pay attention to any damages on the unit caused by extensive usage.
- Ventilate the room occasionally where the unit is installed.
- Remove the power plug when cleaning the unit.

POWER SUPPLY



Time Delay Fuse : 15 Amps
Rated Voltage : 115V

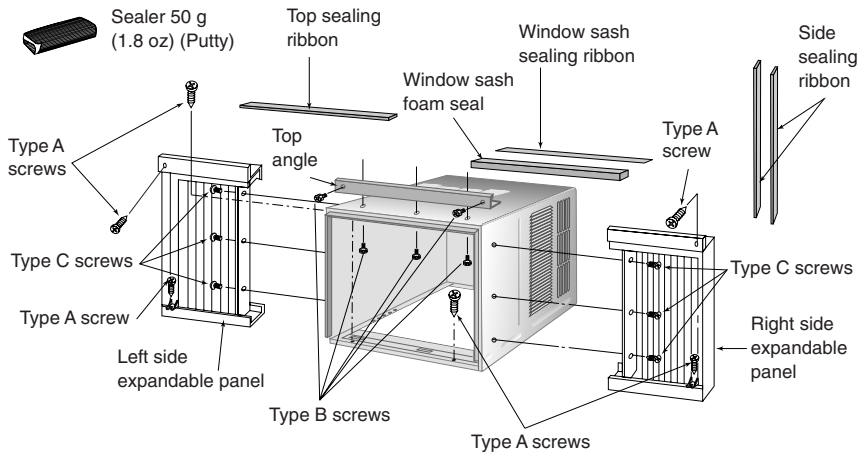

INSTALLATION BOX CONTENTS



SCREW FURNISHED

Type A (Qty 6)	Type B (Qty 5)	Type C (Qty 6)
		
Wood Screw	Machine Screw	Tapping Screw

SUGGESTED TOOL LIST

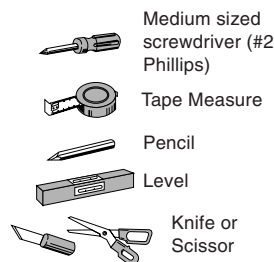

ACCESSORIES

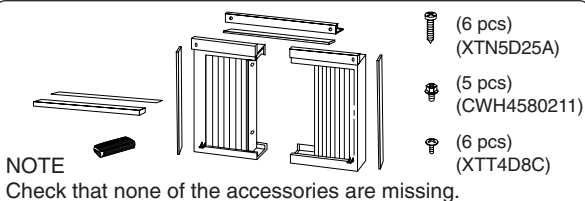

SELECT THE BEST LOCATION

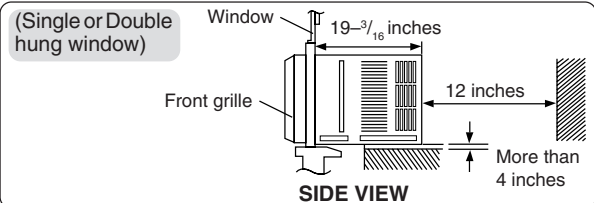

WINDO

- Hot sun ra
of the cab
heat load.
exposed t
building an
while provid
air to be exl
(both sides).

This unit is de
standard double

NOTE

The unit may al
however, observ
opening without v

INSTALLA

- 1 Remove th
screws an
- 2 Slide the c
cabinet.

HOW T

Top :

Type B s

NOT
This
of ?

- A'
- I'
-

e shows the A'
o the left side.

INSERT THE

ach the (part
CZ-

Slot in the filter and the
frame (part no. CZ-SFW6P) to
the front grille.

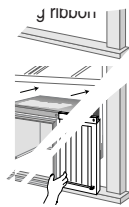

The filter and the frame can be obtained separately
from your nearest service center.

INSERT THE AIR FILTER

Attach the air filter to the intake grille

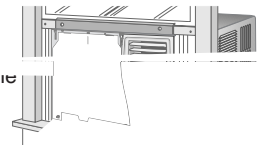

PLACE FRONT INTAKE

Slide the front intake
tabs and then push

Expand the expandable panel fully into the grille of the
window, secure the expandable panel,
for mounting frames to the bottom of the window
using screws type A and 2 screws type B.
• Secure the cabinet using wood screws type
• Cut the sash foam seal to the proper size and
seal the top of the side window
with the sash.
• When the unit and window are
applied with the installation kit fo

② Remove the air filter.

Tilt up and pull out the air filter by the holder.

ward on cabinet near the power cord, and pull releases.
et and pull the grille outward to the left to release
e than 3 inches to prevent the two top tabs from
op tabs from slots at the top of the cabinet.

ADDITIONAL)

which is designed to splash the condensed efficiency, thus producing a splashing sound. e an outside drainage by using the following of performance.

lower to the rear for necessary condensate

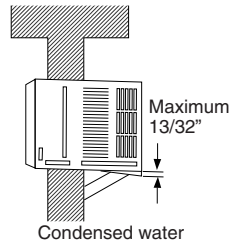

out from

5

OPERATING THE UNIT

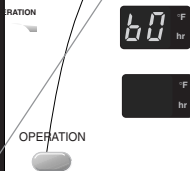

beep sound will indicate changing setting.
COOL mode
 presence of cooling unit to your
FAN mode
 Beeping fan indicator

SETTING DISPLAY TEMPERATURE

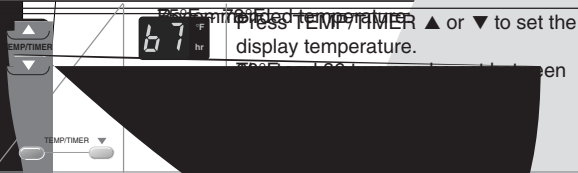

Press **TEMPTIMER** ▲ or ▼ to set the display temperature.



MODE

NOTE: direction of the airflow

ADJUSTING HORIZONTAL

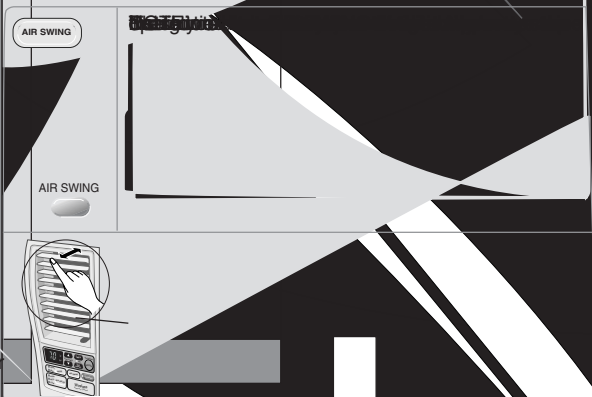

NOTE

- When fan speed setting will be memorized and the indicator

ECONOMY OPERATION



To reduce power consumption:

- Press ECONOMY.
- To cancel this operation, press once more.

ECONOMY

Recommended for electricity cost saving. When economy button is pressed, target temperature is shifted up 1°F, this will reduce operating time of the compressor and therefore reduce power consumption. It may, however, take a little longer for the compressor to cycle on and thereby increase the room temperature slightly. Economy mode will override your current set fan speed to "LOW". However, the display will still show the current set fan speed. Compressor stops when the room temperature reaches the target temperature. It turns on again when the room temperature rises. When power failure occurs, the economy setting is canceled. Once power is resumed, reset the economy setting.

SETTING THE OFF TIMER

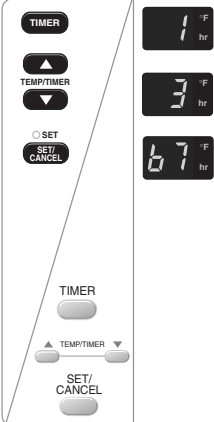

When the air conditioner in operation:
Press the TIMER button.
The SET/CANCEL indicator light will blink awaiting for setting.
Press the TEMP/TIMER ▲ or ▼ button until the preferred hour of operation is reached.
Press the SET/CANCEL button to complete the setting. At this time, the SET/CANCEL indicator light is steady instead of blinking.

NOTE
The hour reading will change back to the set temperature reading after 10 seconds. (You can also revert to temperature setting immediately by pressing the TEMP/TIMER ▲ or ▼ buttons again.)

CHECK TIMER SETTING DURING OFF TIMER

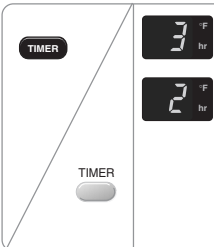

Press the TIMER button to check the remaining programmed timer setting. The figure will be displayed for 10 seconds then will automatically switch back to temperature setting.

NOTE
The timer figure will change according to the time remaining (if you set it to turn off 3 hours from now, the timer will show "2" at an hour later).

CANCEL TIMER SETTING DURING OFF TIMER

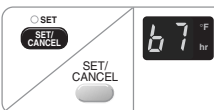

Press the SET/CANCEL button to cancel the timer setting. The SET/CANCEL indicator light will turn off. However the temperature remains displayed.

SETTING THE ON TIMER

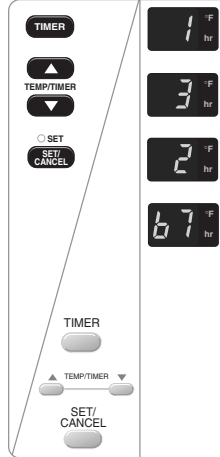

When the air conditioner in operation:
Press the TIMER button. The TIMER indicator light will blink to await for setting. Press the TEMP/TIMER ▲ or ▼ button until the desired hour for operation is reached. Press the SET/CANCEL button to complete the setting. At this time, the TIMER indicator light is steady instead of blinking.
The display will show the remaining hour to the start of the operation (if you set to turn on 3 hours from now, the timer will show "2" at an hour later).
When set time is reached, the air conditioner starts the operation under the previous setting mode and the TIMER indicator will light off. Now, the previous set mode and the fan speed will light up. Simultaneously, the display will show the setting temperature.

CHECK TEMPERATURE/MODE/FAN SPEED SETTING DURING ON TIMER

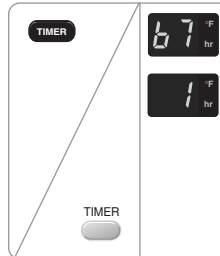

Press the TIMER button. The TIMER indicator light will blink and the previous temperature setting will be shown. Simultaneously, MODE and FAN SPEED indicator will light up. This indication will last for 5 seconds, and then the display will show the remaining time. MODE and FAN SPEED indicator light will turn off. At this time, the TIMER indicator light is steady instead of blinking.

CHANGE TEMPERATURE/MODE/FAN SPEED SETTING DURING ON TIMER

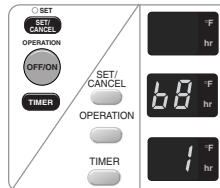

Press the SET/CANCEL button to cancel the timer setting.
Press the OPERATION. Set the desired mode and the fan speed. Then press OPERATION button to stop operation. Start the TIMER setting again by repeating the step from the "Setting the on timer" procedures).

CANCEL TIMER SETTING DURING ON TIMER

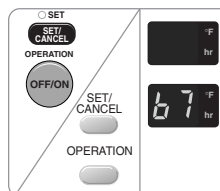

Press the SET/CANCEL button to cancel the timer setting. The SET/CANCEL indicator light will turn off. To operate the air conditioner before reaching the set timer:

- Press the SET/CANCEL to cancel the timer.
- Press the OPERATION button to turn on the unit.

Model		HQ-2102UH	HQ-2122UH
COOLING CAPACITY	Btu/h	10,000	11,500
ELECTRICAL RATING	Phase	Single	←
	Frequency (Hz)	60	←
	Voltage (V)	115	←
	Current (Amps)	8.7	9.8
	Input (W)	980	1120
EER	(Btu/W.h)	10.2	←
MOISTURE REMOVAL	(Pints/h)	2.5	3.0
ROOM AIR CIRCULATION	(Cf/min)	320	330
DIMENSIONS	Height	37.5 (14-25/32")	←
	Width	56 (22-1/16")	←
	Depth	60.6 (23-27/32")	←
NET WEIGHT	kg (lb)	35 (77)	←
GROSS WEIGHT	kg (lb)	39 (86)	←
NOISE LEVEL	Indoor (Hi/Lo)	50/46	51/47
	Outdoor (Hi/Lo)	57/54	58/55

* Specifications are subject to change without notice for further improvement.

HELPFUL INFORMATION

Random Auto Restart

- Operation will automatically resume under the previous operation mode.
- If the unit was set to TIMER mode, operation will not resume automatically.

Timer Setting

- When power failure occurs, the timer setting is canceled. Once power returns, reset the timer.

ENERGY SAVING HINTS

- Setting the temperature 1°F higher save 10% electricity costs.
- Clean the air filter every 2 weeks. Regular cleaning of the air filter preserves efficiency.
- Keeping openings closed keeps cool air in and hot air out.
- Avoid direct sunlight and heat.
- For health reasons do not overcool your room.
- Your air conditioner's cooling capacity should match your room size.



**Panasonic Consumer Electronics Company,
Division of Matsushita Electric Corporation
of America**

One Panasonic Way
Secaucus, New Jersey 07094

**Panasonic Sales Company,
Division of Matsushita Electric of Puerto Rico, Inc.,**

Ave. 65 de Infanteria, Km. 9.5
San Gabriel Industrial Park
Carolina, Puerto Rico 00985

Quasar Room Air Conditioner Limited Warranty

Panasonic Consumer Electronics Company or Panasonic Sales Company (collectively referred to as “the Warrantor”) will repair this product with new or refurbished parts in case of defects in material or workmanship, free of charge, in the USA or Puerto Rico in accordance to the following (All time periods start from the date of the original purchase).

SEALED REFRIGERATING SYSTEM (compressor and interconnecting tube): FIVE (5) YEARS - PARTS AND LABOR

ALL OTHER COMPONENTS: ONE (1) YEAR - PARTS AND LABOR

In-home service in the USA can be obtained during the warranty period by contacting a Panasonic Service Company (PASC) Factory Servicenter listed in the Servicenter Directory. Or call toll free, 1-800-211-PANA(7262), to locate a PASC authorized Servicenter. In-home service in Puerto Rico can be obtained during the warranty period by calling the Panasonic Sales Company telephone number listed in the Servicenter Directory.

Note: If the unit is installed at the other than normal window height and/or has been custom-installed (e.g., through the wall), the customer is responsible for removing the unit from its installation prior to the performance of in-home service.

This warranty is extended only to the original purchaser. A purchase receipt or other proof of date of the original purchase is required for service and parts replacement under this warranty.

This warranty only covers failures due to defects in materials and workmanship and does not cover normal wear or cosmetic damage. The warranty does not cover damages which occur in shipment, or failures which are caused by products not supplied by the warrantor, or failures which result from accident, misuse, abuse, neglect, mishandling, misapplication, faulty installation, maladjustment of customer controls, improper maintenance, alteration, modification, power line surge, lightning damage, improper voltage supply, commercial use such as hotel, office, restaurant, or other business or rental use of the product, or service by anyone other than a PASC Factory Servicenter or a PASC authorized Servicenter, or damage that is attributable to acts of God.

LIMITS AND EXCLUSIONS

There are no express warranties except as listed above.

THE WARRANTOR SHALL NOT BE LIABLE FOR INCIDENTAL OR CONSEQUENTIAL DAMAGES RESULTING FROM THE USE OF THIS PRODUCT, OR ARISING OUT OF ANY BREACH OF THIS WARRANTY. ALL EXPRESS AND IMPLIED WARRANTIES, INCLUDING THE WARRANTIES OF MERCHANTABILITY, ARE LIMITED TO THE APPLICABLE WARRANTY PERIOD SET FORTH ABOVE.

Some states do not allow the exclusion or limitation of incidental or consequential damages, or limitations on how long an implied warranty lasts, so the above exclusions or limitations may not apply to you.

This warranty gives you specific legal rights and you may also have other rights which vary from state to state. If a problem with this product develops during or after the warranty period, you may contact your dealer or Servicenter. If the problem is not handled to your satisfaction, then write to the Consumer Affairs Department at the company address indicated above.

SERVICE CALLS WHICH DO NOT INVOLVE DEFECTIVE MATERIALS OR WORKMANSHIP AS DETERMINED BY THE WARRANTOR, IN ITS SOLE DISCRETION, ARE NOT COVERED. COSTS OF SUCH SERVICE CALLS ARE THE RESPONSIBILITY OF THE PURCHASER.

[For assistance, please call: 1-800-211-PANA (7262) or send e-mail to consumerproducts@panasonic.com]